









VERIFICA

Alunno _____ Classe _____ Data _____

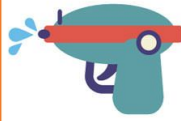
La tabella riporta gli acquisti di alcuni clienti in un negozio di giocattoli. Completala.

La tabella riporta gli acquisti di alcuni clienti in un negozio di giocattoli. Completala.





Acquisto	Prezzo	Pagamento	Resto ricevuto
	€ 35,00		1 banconota da € e 1 banconota da €
	€ 63,50	1 banconota da € e 1 banconota da €	 
	€ 19,94		1 moneta da € e 1 moneta da €
	€		 

Acquisto	Prezzo	Pagamento	Resto ricevuto
	€ 37,50		2 monete da € e 1 moneta da €
	€ 6,80	1 banconota da €	
	€ 78,00		1 banconota da € e 1 moneta da €
	€		 





Calcola il totale delle seguenti somme:

	<p>€</p>
	<p>€</p>
	<p>€</p>
	<p>€</p>

Calcola il totale delle seguenti somme:





	<p>€</p>
	<p>€</p>
	<p>€</p>
	<p>€</p>





QUANTI SOLDI DEVO PAGARE?
CERCHIA SOLO I SOLDI CHE DEVI USARE PER PAGARE IL CONTO





<p>*** RISTORANTE *** "AI PORTICI" Via Calmaggiore 10 (+39) 0422 333 999</p> <p>*****</p> <p>13/11/2015 11:11</p> <p>Pasta vongole € 5,00 Insalata mista € 2,00 Acqua naturale € 1,00</p>		 
<p>Total € 8,00</p> <p>** Arrivederci e buona giornata **</p>	 	

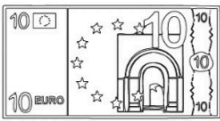

QUANTI SOLDI DEVO PAGARE?
CERCHIA SOLO I SOLDI CHE DEVI USARE PER PAGARE IL CONTO

<p>da Pino</p> <p>Viale della Repubblica 88 (+39) 0388 959 333</p> <p>*****</p> <p>13/11/2015 11:11</p> <p>Pizza Margherita € 5,00 Pizza Prosc Funghi € 6,20 Dolce (x2) € 4,20</p>		 
<p>Total € 15,40</p>	   	

<p>*** SOUVENIRS *** "SOLE E MARE" Via Lungomare 55 (+39) 0498 222 252</p> <p>*****</p> <p>13/11/2015 11:11</p> <p>T-shirt delfino € 10,00 Cartolina € 0,50 Francobollo € 0,20</p>		
<p>Total € 10,70</p> <p>** BUONE VACANZE **</p>	  	

<p>THE SPACE</p> <p>Via Salina 74 thespace@cinema.com</p> <p>*****</p> <p>16/11/2015 18:30</p> <p>Inside out € 7,00 Pop corn € 1,00 Coca cola € 1,10</p>		
<p>Total € 9,10</p>	  	

<p>*** BAR *** "DA MARIO" Via Garibaldi 2 (+39) 0477 888 987</p> <p>*****</p> <p>15/10/2015 14:31</p> <p>Brioche (x4) € 4,00 Cappuccino (x5) € 5,50 Bombolone crema € 2,00</p>		
<p>Total € 11,50</p> <p>** Arrivederci e buona giornata **</p>	   	

<p>McDonald's</p> <p>Viale Cairoli 9 I'm loving it</p> <p>*****</p> <p>20/11/2015 14:22</p> <p>Big Mac € 4,95</p>		  
<p>Total € 4,95</p> <p>** BUON APPETITO **</p>	